

## Designing Futures with Pasts

Rediscovering and transforming abandoned paths of food preservation under today's paradigm of sustainability

### Abstract

The impending climate catastrophe gives rise to an increased environmental awareness among many designers, who direct their work towards the paradigm of sustainability. While designing with an 'ecological lens' is necessarily oriented towards the future, we highlight the *past* as an inspiring realm to explore. Rather than recycling materials, we encourage the *recycling of ideas* as a combination of historiographic and speculative design methods.

We will present a framework that extends the idea of design as a 'projecting' activity into the idea of design as a constant negotiation process about the relevance and appropriateness of current and past technologies. Design revolves not just about *what will be*, but to a large extent about *what should remain* and *what should recur*, or as Jan Michl put it: "seeing design as redesign" (Michl 2002). We will illustrate the thought of *designing futures with pasts* by means of a research project that aims at developing a refrigerator for circular economy. The refrigerator – as the currently dominant technology to preserve food – will serve as a starting point to show how artefacts and architecture as well as human skills and knowledge in the preparation and preservation of food are historically interlinked. The history of food preservation unfolds not only along the evolution of the refrigerator, but encompasses household techniques like smoking, curing and fermenting, as well as long-forgotten architectural 'answers' such as deep-freeze community buildings. We will revisit three historical examples of food preservation and present the method 'throwing' past ideas into the future.

Three main arguments are presented in this richly illustrated paper: First, that historiography is a form of designing, second, that designing is constituted and influenced by path dependencies (cf. David 1985) that are deeply rooted in the past and third, that the past is a valuable source of inspiration when designing for sustainable development. Looking at history becomes a way of "mental window shopping" (Simon 1985, 188) for approaches that are to be reactivated and transformed.

### Introduction

Major socio-technical transformations and shifting cultural values affect design practices just as much as they are shaped by design. Currently, the impending climate catastrophe is giving rise to an increased environmental awareness among many designers, who – like us – are trying to deal with the challenges and contradictions of the paradigm of sustainability (Blühdorn 2017). With these normative goals growing in importance, a growing number of design

CHRISTOPH  
T O C H T R O P

DUSTIN  
J E S S E N

FOLKWANG UNIVERSITY OF  
THE ARTS, ESSEN  
AND  
WUPPERTAL INSTITUTE FOR  
CLIMATE, ENVIRONMENT  
AND ENERGY, WUPPERTAL

theories, strategies and methods directed towards sustainable development are currently being developed, tested and applied. Circular economy approaches are particularly popular in the latest design methodology (e.g., Ellen MacArthur Foundation and IDEO 2018), and likewise the discipline of design is addressed in circular economy policies (e.g., Circular Economy Initiative Deutschland 2021, 74; European Environment Agency 2017; Greiff et al. 2021; Tischner and Moser 2015). While designing with an ‘ecological lens’ is necessarily oriented towards the future, we would like to highlight that the past is an incredibly inspiring realm to explore. As many sustainable design strategies focus on the recycling of materials, we encourage the *recycling of ideas*. Thus, *designing futures with pasts*.

First, we will present a conceptual framework that is just as *hypothetical* as it is *methodological*. We *hypothesise* that it is a basic *method* of design to question the relevance and appropriateness of existing technologies or cultural practices. By negotiating what to maintain and what to change, every design intervention challenges the validity of what already exists. While designing is often described as a primarily future-oriented activity, it actually revolves not just around what will be, but also to a large extent around what should *remain* and what should *recur* – “seeing design as redesign” (Michl 2002). As designers we eventually always negotiate with the existent and the past. By approaching this negotiation process in a more conscious and methodical way, we can show how our concepts and ideas are deeply rooted in history.

In the following we will illustrate the method of designing futures with pasts by means of the research project “Circular by Design”, which aims at developing a refrigerator for the circular economy. The refrigerator – as the currently dominant technology to preserve food in private households – will serve as a starting point to show how artefacts and architecture as well as human skills and knowledge in the preparation and preservation of food are historically interlinked. The history of food preservation unfolds not only along the evolution of the refrigerator (as a relatively young artefact), but also encompasses household techniques like smoking, curing and fermenting, long-forgotten architectural ‘answers’ such as deep-freeze community buildings, as well as devices that evolved around the global trade in natural ice.

Eventually, we will apply our method by revisiting three historical examples of food preservation and ‘throwing’ them into the future as speculative designs in order to discuss their potential to contribute to sustainable development.

### **Designing Futures with Pasts – A Conceptual Framework**

The PPPP-diagram by Dunne and Raby (2013, 5) – which has undergone a long evolution in futurology (Candy 2010, 35; Voros 2003, 13; Hancock and Bezold 1994, 25; Amara 1974) – provides a

framework to distinguish between probable (P), plausible (P) and possible (P) futures, in order to debate along these plausibilities which scenarios are actually preferable (P) (Figure 1). However, as the saying goes: if you want to design the future, you have to know the past. And, even if this perspective can be found in the methodological canon (Meinel and Leifer 2011, 15), we believe that it receives too little attention as a fundamental method of design. While the focus of product design, especially in advertising, is often placed heavily on novelty, it might be a more honest perspective to acknowledge that products are the result of a continuous socio-technical evolutionary process, and from one generation to the next, most of their characteristics remain basically unchanged.

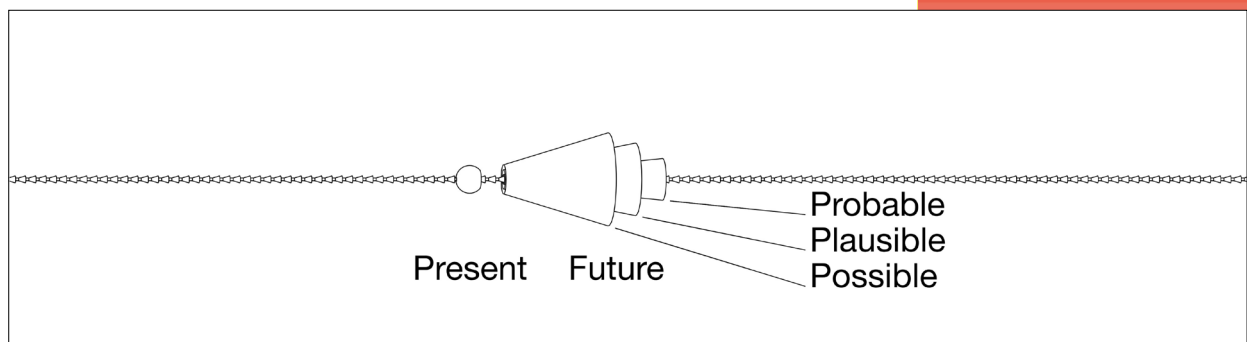

Figure 1. “PPPP-Diagram”, adapted by the authors from Dunne and Raby (2013).

For the purpose of visual clarity, we skip the advanced discourses on space and time in our scheme, and use an operational understanding of time as a continuum, without denying that one may construct multiple pasts, presents and futures (Rendall 2008). The thought of a “continuum” between a “range of plausible pasts” and a “range of plausible futures” was already depicted in “The Cone of Plausibility” diagram published over 30 years ago by Charles W. Taylor (1990, 14), who developed it to foster strategic thinking among military and corporate leaders. Just as we look from the present into the future and speculate about it, we also speculate about the past. Although it seems as if the past is unchangeable and the future can still be shaped, both are eventually human creations and constantly subject to changing world views. The process of writing history and the process of designing appear to be surprisingly similar – oftentimes highly speculative – activities. Although we might look “myopic” (Simon 1985, 188) into the future and a little more hyperopic into the past (which we are indicating by the different sized cones in Figure 2), we speculate just as much about what was as about what will be.

Moving with these ‘optical principles’ through time (Figures 2 and 3), some futures slowly sharpen and become the present, while some pasts gradually fade away, and vice versa. However:

*“That which we design is not produced without pre-conditions. Our lives are governed by circumstances. We do not decide freely, but instead move within a field of standards, values, fixed conditions. The things we create [...] are subject to these conditions. They*

are present in the world into which we are thrown, are given—and are in turn transformed through the designs we oppose to the world projectively.” (von Borries 2020, 5)

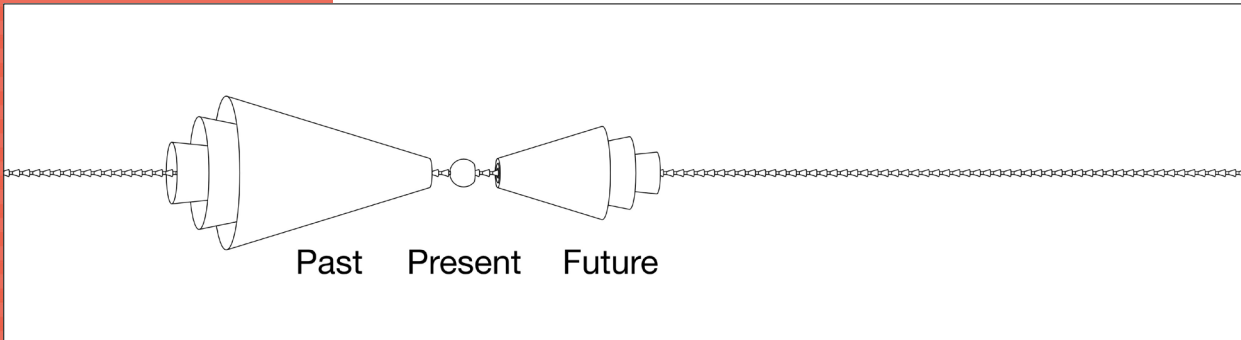

Figure 2. “The Cone of Plausibility”, adapted by the authors from Taylor (1990).

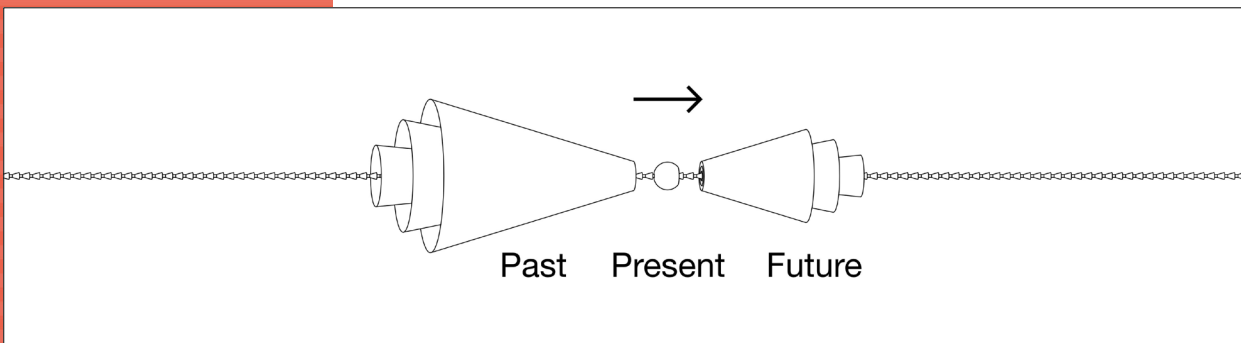

Figure 3. “The Cone of Plausibility” as an ‘optical device’ is moving with us through time.

Designing as a (professional) activity is constituted and influenced by path dependencies (David 1985) that are deeply rooted in the past. So, instead of understanding the activity of designing as a point in the present from which to speculate unconditionally about futures, it should be understood as a *space* (Figure 4), which the musician and visual artist Brian Eno aptly described like this: “‘Now’ is never just a moment. The Long Now is the recognition that the precise moment you're in grows out of the past and is a seed for the future. The longer your sense of Now, the more past and future it includes” (Eno 1995). We picked up on this idea in our diagram with the metaphor of a zip tie (Figure 4), which provides some *space* to move in a new direction, and eventually snaps into place on the axis of time; transformation happens step by step.

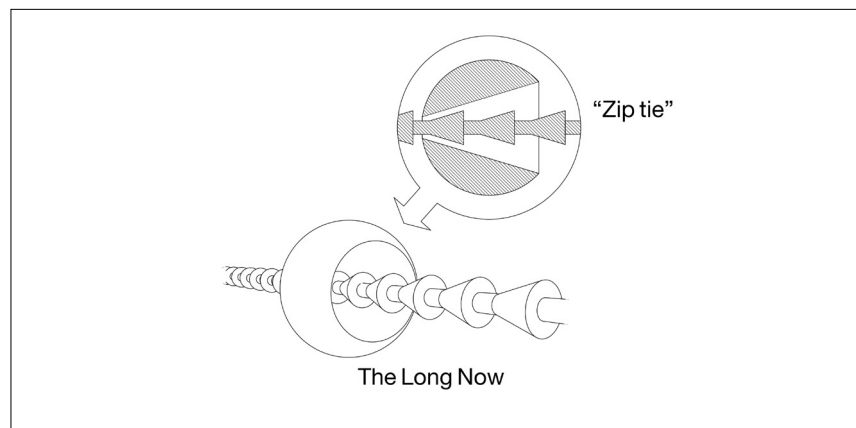

Figure 4. The present as a conceptual space that allows a step-by-step transition towards possible futures.

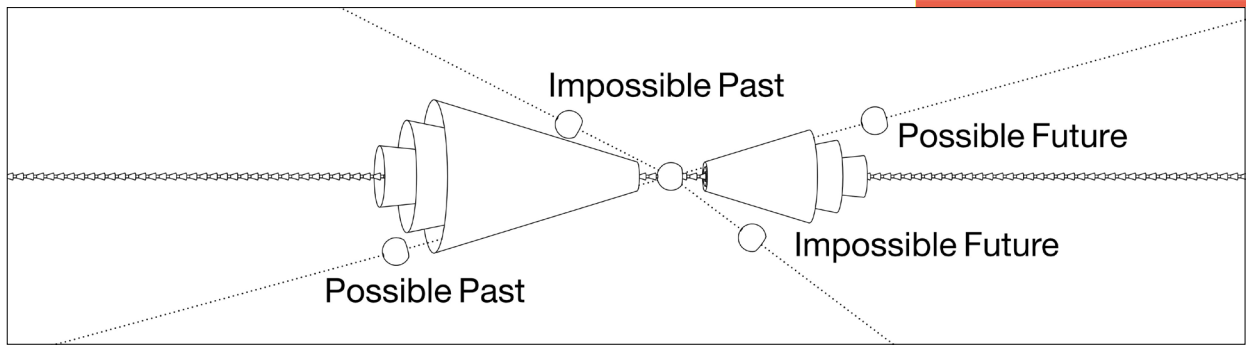

Figure 5. While infinite pasts and futures are imaginable, most of them are impossible.

When a future once thought possible actually becomes the present reality, this always means that numerous other projections – even if they once seemed very probable – have not come true: they have become another impossibility (Figure 6).

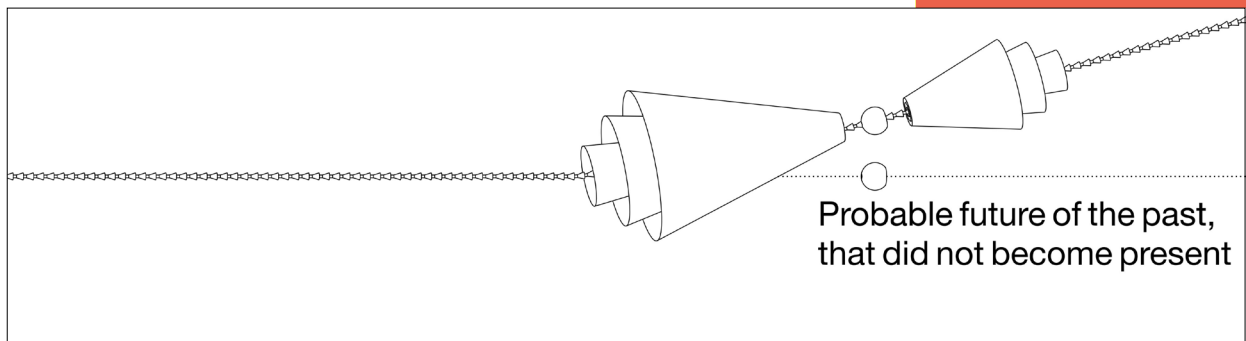

Figure 6. Some things that seemed probable in the past have not come to pass.

In light of our living in what might once have been a hard-to-imagine future, we might also look back on past events and developments from a new angle (Figure 7). As we, for example, shift from a society of smokers towards a non-smoking society – a development that can be observed in Germany and many other European nations – the image of passengers smoking on a plane comes to appear more and more bizarre. Individuals' perceptions of past events as well as predictions about the future are subject to a biased view from the present. Time is constantly distorted, compressed and bent.

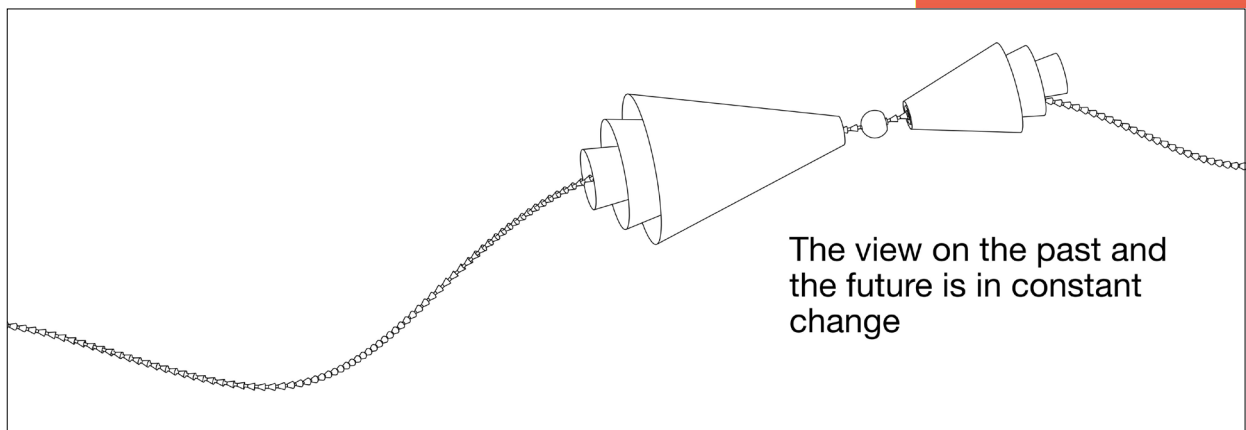

Figure 7. As we move towards the future, the perspective on it changes, as does that on the past.

Old technologies, forgotten crafts or abandoned practices can suddenly appear attractive again and come to the attention of designers through their contemporary perspective on the past (Figure 8). Today, some historical artefacts and technologies might reappear on designers' radar due to their increased ecological awareness.

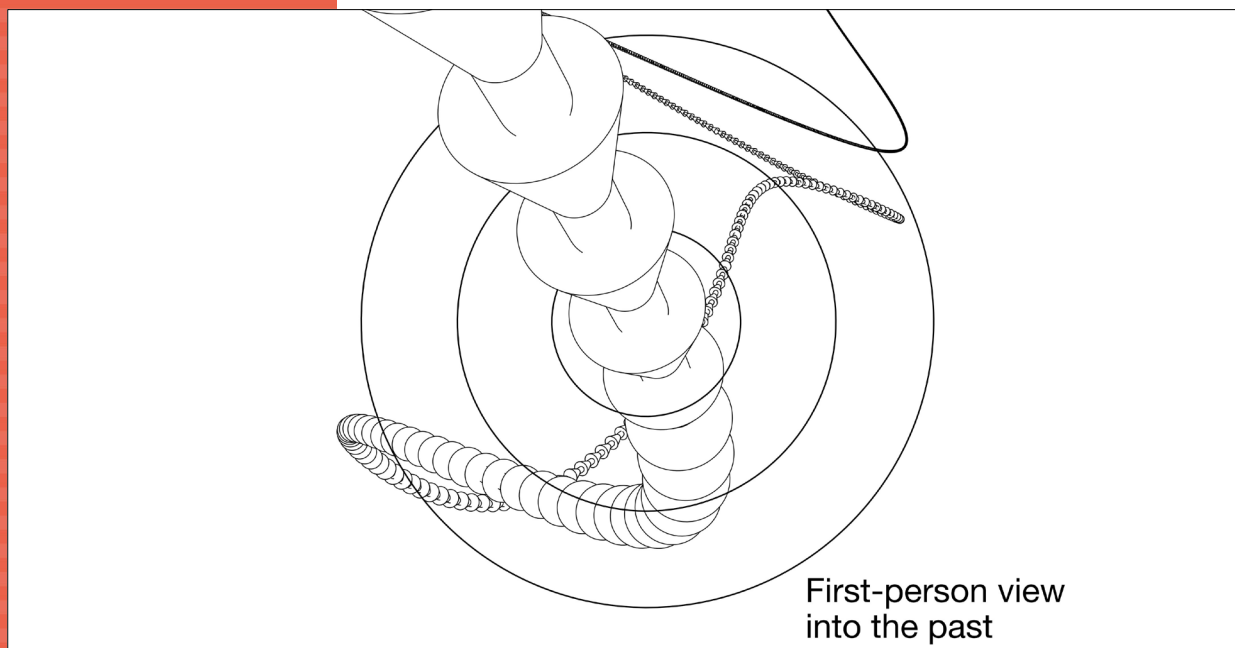

Figure 8. Looking through today's radar of plausible, probable and possible pasts.

While we seem to be confronted with new futures at an ever faster pace (Toffler 1971), the art of designing the transition (Irwin 2015; Liedtke et al. 2019) towards more sustainable futures is becoming increasingly important. Contrary to widespread belief in 'progress' through so-called 'leap innovations', we are proposing considered *steps 'back' into the future* by recycling ideas that have been forgotten or abandoned (Figure 9).

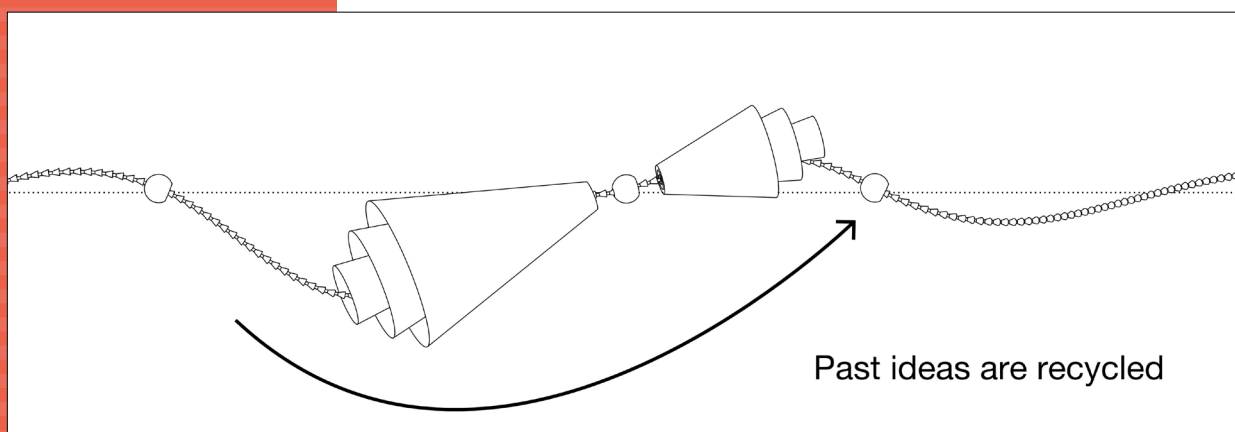

Figure 9. Some historical resources can be reused for the future.

In the following we will show how we applied the theoretical considerations above in the concrete case of the research project "Circular by Design". Before we dive into the methodological application, we will briefly explain the particular framework, constraints and briefing of the research project.



## Designing a Refrigerator for Circular Economy

The refrigerator has a prevalence rate of almost 100% in households of industrialised countries (Rao and Ummel 2017), and it is deeply embedded in our everyday behaviour patterns. Thus, the refrigerator offers great potential to be rethought with a view on 'Planetary Boundaries' (Steffen et al. 2015). It has a particular impact on Sustainable Development Goal (SDG) 2, 'zero hunger', and SDG 12, 'responsible consumption and production', but it is further linked to all other SDGs (Rockström and Sukhdev 2016). The circular economy – as an effort to reduce the amount of resources needed to produce products (Potting et al. 2017) – is an important concept for addressing the SDGs (Cui 2021, 18). The development of circular economy approaches playing an increasingly important role in today's product design is also evident in the design research project "Circular by Design". Various institutions (an institute for resource technologies, an institute of application-oriented sustainability research, a team of design researchers with industrial design backgrounds) and stakeholders (a manufacturer of refrigerators, a retailer for kitchen appliances, several recycling companies) are working together to develop a refrigerator for the circular economy. The project is designed to involve many actors along the current (uncircular) material path of refrigerators. Design takes on a transdisciplinary and synthesising role, trying to transfer the findings and insights of the respective project partners into concepts and interventions. In contrast to professional design contexts, where the designers would presumably be bound to the interests of the manufacturer, or at least to the strong forces of the market, the academic context enables design to take on a research role that is to some extent emancipated from industry and economy. The creative and epistemic freedom of this particular project goes so far that it is even possible to come up with concepts and scenarios in which private refrigerators are made completely redundant. This reflects that in the "era of 'R'" (Stahel 2019, 27), it is in accordance with the European Union's waste hierarchy that strategies of *prevention* take precedence over strategies of reuse, recycling, (energy) recovery or disposal (European Union 2008, sec. 4).

When the prevention of a product becomes a possible response to the challenge of redesigning a product, we must look beyond its physical existence and examine the socio-technical context in which it is situated (Latour 1999, 186). Existing laws, regulations, standards, production, distribution, logistics, ways of use, social conventions, maintenance, repair, disposal or recycling practices: these all might inform the outcome of the design process. As part of the kitchen, the refrigeration unit is in direct connection with both humans and non-human "actants" (Latour 2010). As an interim storage device for food, it has many different relationships to other products, systems and social practices: packaging sizes, supermarket shelves, eating habits, food culture, recipes, beverage manufacturers, birthday cakes, festive roasts or daily eating routines – they all influence and condition each other, and form a network of relationships. It is crucial to understand the elements

and dynamics of such a system in order to discover pathways of action for more climate justice possibilities (cf. Bickel 2021).

The recently published Ecodesign Directive (European Commission 2016) sets out rules for improving and assessing the environmental performance of products. This puts the evaluation methods on a much broader basis than the well-known energy efficiency label has done so far. The refrigerator is a familiar assessment object in this context. However, with regards to the open-ended project outcome, it remains an open question how to evaluate scenarios that aim to replace the evaluated products with a solution (e.g., a 24/7 food delivery service) that has completely different system boundaries.

In meeting the challenge of designing with a systemic approach, there are plenty of design guides that provide a multitude of methods for designing a more sustainable product (cf. Gründl and Institute of Design Research Vienna 2014; BMUB and UBA 2015; Simonse 2017; Bakker et al. 2020; Boeijen et al. 2014). The Circular Design Guide from IDEO and the Ellen MacArthur Foundation offers a variety of easily accessible creative methods (Ellen MacArthur Foundation and IDEO 2018) aimed at getting closer to the goal of a circular economy; for example, by using a simplified life cycle assessment for design processes (Liedtke et al. 2019). A method for dealing creatively with the past seems to be a little-noticed idea. While existing design methods draw their creative potential from a strong orientation to the future, we suggest looking at the past as creative material that can be transformed and reactivated using current knowledge and technologies.

## **Designing by Throwing Pasts into Futures**

In the following, the refrigerator is understood as one among many answers to the question: how can food be preserved and made accessible for longer periods of time? This leads us to the research question: what can we find in the history of food preservation that has the potential to be used again in the future? We will breathe life into the theoretical framework described in the first section by means of three examples: products, architecture and knowledge that once played a role in the preservation of food are thrown into the future to discuss their potential in contributing to sustainable development.

### ***Rediscovering Fermentation***

Before we were able to cool down food, fermenting, curing, smoking, pickling, drying or sugaring were prevailing practices to preserve food. All of these methods have in common that they greatly alter the taste of the food they preserve. When cabbage is fermented, sauerkraut is produced: a process that is triggered by lactic acid bacteria. The invention of Sauerkraut is, however, much



more than the invention of long-lasting cabbage, as it affected people's lives in profound ways. Having a much longer shelf life than white cabbage, sauerkraut historically played an important role in the food supply during the winter months. The preparation of food months before and dislocated from its consumption had effects on the division of labour, as well as on food supplies for military units. Napoleon is said to have pushed the invention of the can to provide his units with food more flexibly (cf. Wilson 2012). The stereotypical term 'Krauts' for Germans, dating from World War II, suggests how formative this food must have been, while the 'Krauthobel' – a kitchen tool reminiscent of a carpenter's slicer – and the sauerkraut barrel demonstrate how there are even some specialised artefacts that evolved around the production of this particular food.



Figure 10. Making sauerkraut (between 1910 and 1920) Credit: National Photo Company Collection, available at: [https://commons.wikimedia.org/wiki/File:Food\\_Adm.-\\_making\\_sauerkraut\\_LCCN2016824355.tif](https://commons.wikimedia.org/wiki/File:Food_Adm.-_making_sauerkraut_LCCN2016824355.tif).

Thanks to the invention and adoption of alternative processes for preserving food, we nowadays enjoy fermented foods as a delicacy, or as Bee Wilson says: “Countless delicious foodstuffs might never have been invented if refrigeration had been available sooner” (Wilson 2012). Artificial refrigeration has made possible a method that preserves food with virtually no change in taste.

In this light, the widespread use of refrigerators has not only made housework easier; it also means that we can eat a more balanced and healthier diet today (Park et al. 2011; Täubrich and Tschöcke 1991). Fermented products have experienced a revival in recent years. “The Noma Guide to fermentation” (Redzepi and Zilber 2018), published by two-Michelin-star restaurant Noma, highlights this trend. Fermented foods are no longer a necessity, but a taste experience, and more and more varieties are gaining access to ‘our’ kitchens (again): kombucha, vinegar, koji, miso, shoyu, and garum (cf. Redzepi and Zilber 2018).

Fermentation began as a preservation method for staple foods. Without ever completely disappearing from the menu, fermented foods are now reliving their role as delicacies. With today's quest for a more sustainable lifestyle, fermentation is back on the agenda as a delicate staple food (see Figure 11), and it might become even more important in the future, if the necessity to save energy became even more urgent. Preserving food with microorganisms does not require any additional electrical energy, and – unlike frozen vegetables – the preserved food can be stored for longer periods in an almost resource-neutral manner. Fermentation can make a varied contribution to a plant-based diet, which tends to be lighter on resources (Katz 2012). Furthermore, fermented foods are also well suited to join the growing online food trade, where unrefrigerated goods can be handled more easily.

This illustrates how sauerkraut has contributed to the course of history in the past and how new influences are possible through our current perspective. It is unlikely that fermented foods will entirely replace cold chains, but they might become a supplement (illustrated in Figure 11). As market penetration grows, this may even lead to a reduction in refrigerated volumes.

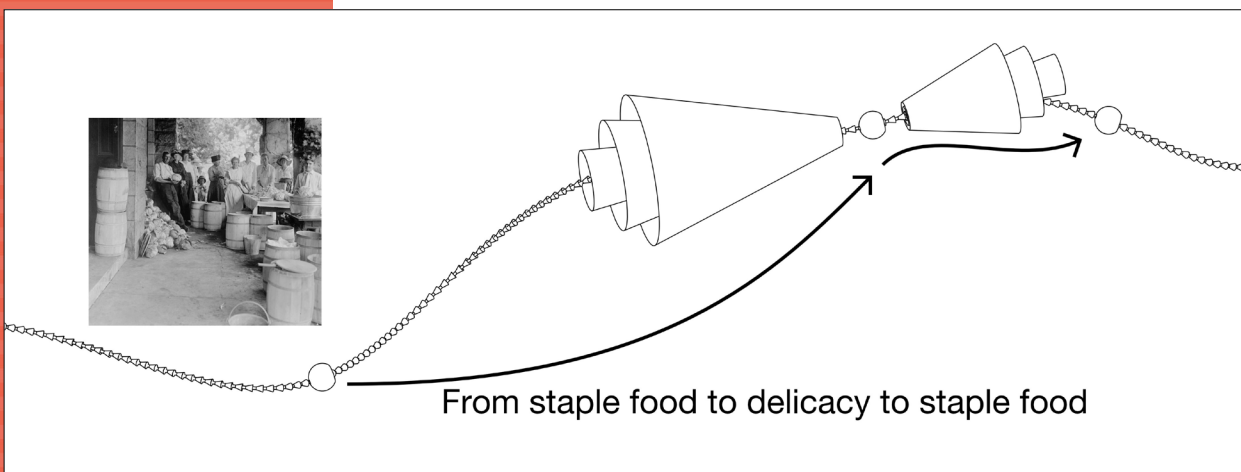

Figure 11. The practice of fermenting could contribute to the proliferation of unrefrigerated foods in the future.

### ***From Deep-Freeze Community Buildings to Food Hubs***

Today, we usually understand the refrigerator as a piece of furniture situated in the kitchen. Historically, the refrigerator has approached the kitchen through many buildings, constructions and artefacts. The pantry on the north side of the house, which can still be found in some houses, refers to a time when ice and cold were a natural product. From today's point of view it is hard to imagine that there was a whole branch of industry involved in the trade of natural ice, but in the nineteenth century ice was industrially mined from lakes, rivers and glaciers during the cold months. This process was done with specially equipped ploughs, saws and ice chutes, and the mined ice was stored in large ice houses throughout the whole year.

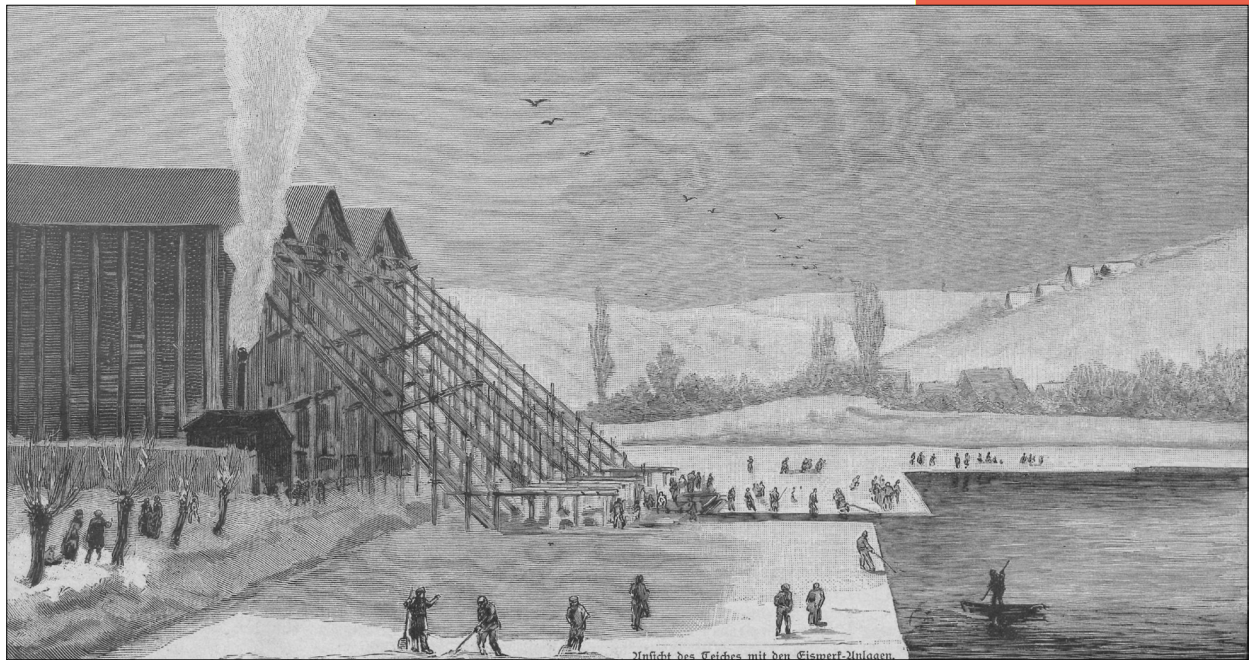

Figure 12. The ice factory at the Mockritzer pond, near Dresden. Credit: "Das Buch für Alle" 1886, copyright expired.

A brief historical review: New York's natural ice demand increased from 12,000 tons in 1843 to 1 million tons in 1879 (cf. Thévenot and Fidler 1979, citing Täubrich and Tschoeke 1991). The ice was sold to breweries, slaughterhouses, cafés, pastry shops, fish and game dealers and eventually to private citizens. Where the demand could not be met with regional natural ice, ice was imported. The first shipload of ice was transported from New York to Charleston in 1799 (Habs 1894, 141). The Wenham Sea Company supported the construction of ice warehouses in cities such as Havana, Charleston and New Orleans in order to sell natural ice there as well. The company reached its export peak in 1872 with 225,000 tons (Täubrich and Tschoeke 1991, 51–67). The principles to produce ice artificially were already laid in 1805 (Giedion 1970 [1948], 601), but it was not until around 1913 that the international trade in natural ice became increasingly displaced by ice from artificial ice factories. To satisfy the need for refrigeration, the production of bar ice made in the artificial ice factories was soon supplemented by cold storage. In addition to the production of bar ice, goods from all over the world were soon traded and stored here. In parallel with commercial customers, the market of private individuals who had an icebox at home – an insulated cabinet filled with ice and food – also grew (cf. Hellmann 1990; Täubrich and Tschoeke 1991). The private refrigerator first replaced the icebox in affluent households, until its use increased rapidly from about 20% to 84% between 1958 and 1969 (in Germany). Artificial cold became mainstream.

During the transition period between the distribution of natural ice to the distribution of refrigerators, there were some pilot projects that might gain relevance again. Before refrigerators were affordable for all, electric community freezers (Figure 13) were implemented in some locations (cf. Wölfel 2016, 94). As these have larger cooling volumes with less surface area per volume, they are favourable in terms of energy efficiency.





Figure 13. “Tiefkühlgemeinschaft” (deep-freeze community) of Waltra in the municipality of Sankt Anna am Aigen, Austria. Credit: Wikimedia. User: “Niki L.” 2020. Published under CC BY-SA 4.0 Licence. Available at: [https://commons.wikimedia.org/wiki/File:Tiefk%C3%BChlanlage\\_Waltra.jpg](https://commons.wikimedia.org/wiki/File:Tiefk%C3%BChlanlage_Waltra.jpg).

From these historical considerations, it can be deduced that today it is not necessarily the private refrigerator that should seem essential to us. In fact, it is the cool chain behind it that ensures that we can transport countless foodstuffs over a long distance and store them for a long time. Once private refrigerators had become accessible to all, shared-use concepts went out of favour, because there was a comprehensible desire to participate in technological progress.

The use of private refrigerators has become a habit today, but it doesn't have to stay that way. Contemporary eating patterns show that the way we cook at home is transforming and, especially following the Coronavirus pandemic, delivery services have seen tremendous growth. For some, the refrigerator may seem like a burden, because it is an unwieldy piece of furniture that needs to be kept neat and clean. This opens up the possibility of reactivating the principle of the communal freezer. We imagine that similar to parcel stations, so-called Food Hubs (see Figure 14) could spread in urban areas. These have refrigerated, non-heated as well as warm holding lockers and are filled by food from delivery services, which are no longer burdened with resource-intensive last-mile delivery (Stelwagen et al. 2021). As they are located not far from people's apartments, they are suitable for daily delivery and collection. On-demand ordering of small quantities must be enabled in this system. In order to fully unfold its sustainable potential, a Food Hub should foster a regional and seasonal food supply (Schmitt et al. 2017). However, making such hubs into a reality depends not only on the design of the products, but especially on the design of the service (European Environment Agency 2017, 26). Nevertheless, Food Hubs could be a stepping stone toward making private refrigerators redundant. Once it was the natural ice that could unfold its cooling effect on warm days through a functioning supply chain. Inspired by this historical approach, we can say: we do not necessarily need a refrigerator; we need fresh food! With new technical possibilities, this food might also be delivered to a new type of community fridge in the future (see Figure 15).



Figure 14. Rendering of the Food Hub concept.

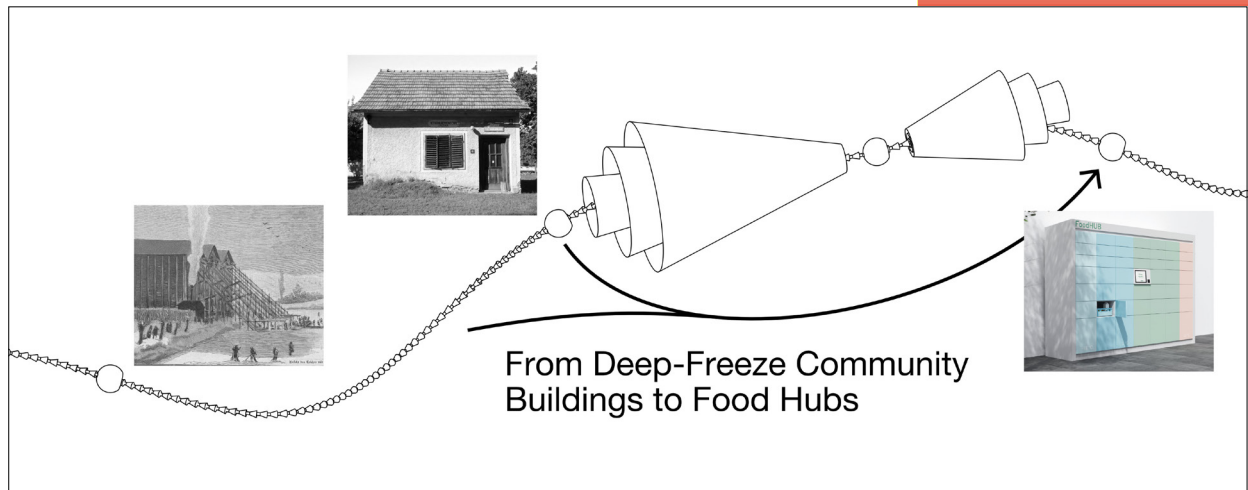

Figure 15. With inspirations from the past, a speculative design concept is created.

### ***From Monitor Top to Cool Front***

In light of today's views on dismountability, reparability and modularity, some refrigerators of the past offer auspicious ways of construction. The “Monitor Top” by General Electric (Figure 16) was introduced to the market in 1926 and is considered the first mass-produced refrigerator in history; by 1931, one million units had already been sold. The cooling unit on the top contained all the technical components and connected them to the cabinet. With a total weight of 212 kg (Museum of Applied Arts & Sciences 2020), the Monitor Top was significantly heavier than today's refrigerators, which weigh about 60 kg with similar overall dimensions (cf. Hellmann 1990; Täubrich and Tschoeke 1991).



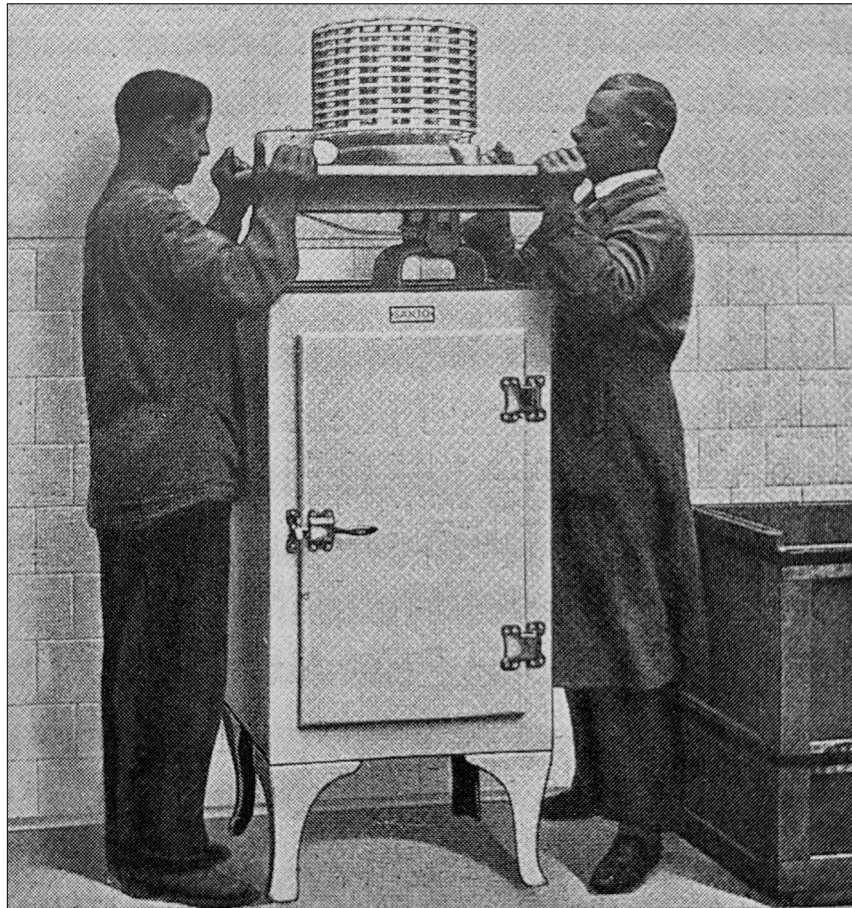

Figure 16. Installation of the cooling unit of a Monitor Top refrigerator. Credit: U. Hellmann 1990 / Copyright by Werkbund-Archiv, Berlin (usage rights requested).

While today's refrigerators belong to the product category of so-called 'white goods', they are better described as 'black boxes' when it comes to what they reveal about their inner workings (Dunne 2008, 20). Rather than presenting its users with an entirely sleek surface, the refrigerator today could be structured like a modular furniture system. Side panels, lids, drawers and shelves could be individually refurbished, replenished or replaced. This could be complemented with the construction principle that the Monitor Top has shown us: one bundled technical unit that is connected with a rather low-tech cabinet. In this way, today's usual closed unit could become a refrigerator that is adaptable and 'learns' over time through continuous improvements (Brand 1995).

The concept "Cool Front" (Figure 17) envisions that all technical elements, such as compressor, heat exchanger, light, thermometer and electronic control system, are placed in the door. For hygiene and energy efficiency, it is beneficial if the inside of a refrigerator has as few openings as possible. The body consists of a modular insulated plastic shell on the inside, which can be extended by adding insulating elements as desired. Enclosed in a standard kitchen body, this results in a product whose components can be repaired and upgraded easily. Dismantling also reduces the transport volume due to the stackability of parts. For the end-of-life phase, the materials can be reprocessed in a focused manner. The result is a highly adaptable refrigerator that performs in a proven manner, but meets key requirements of the circular economy by separating the technological components from the casing (Potting et al. 2017; European Environment Agency 2017).





Figure 17. Rendering of the Cool Front concept.

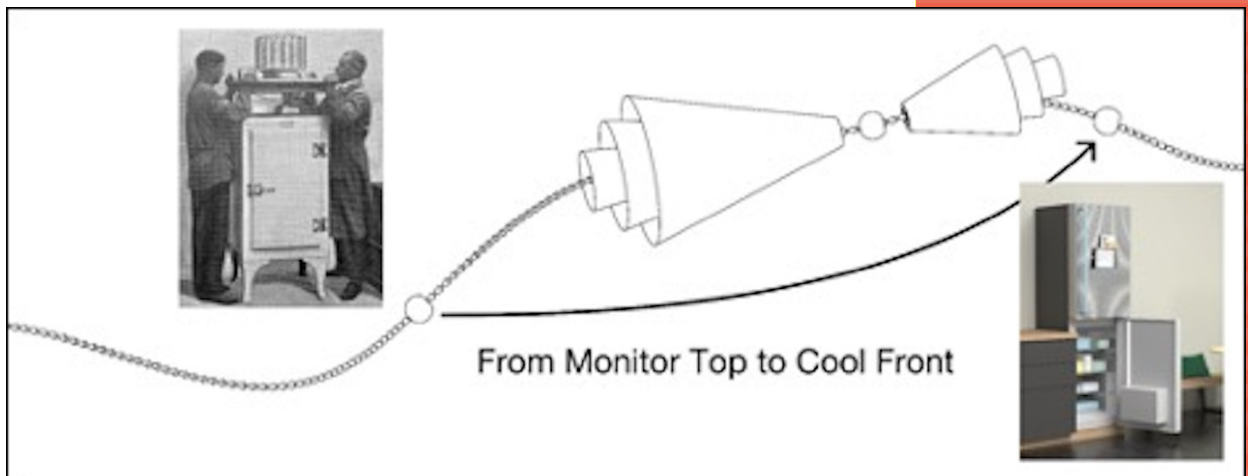

Figure 18. A nearly lost idea is used for a new design.

## Discussion

While techniques of smoking, curing and fermenting were once the means to preserve food, it would be wrong to assert that the refrigerator simply undertook this task. Technological changes have always tended to change much more than their inventors intended, or even imagined.

*“Strictly speaking, a tool is not produced to carry out a defined utilitarian task. Tools are born as challenges to existing concepts of utility. They open up new understandings of what could be useful. Utility is not a given unambiguous need. Ambiguity about utility is what drives new forms of utility.” (Colomina and Wigley 2016, 52)*

While the above-mentioned techniques had a huge impact on the taste of the food they were used to preserve, the refrigerator gave rise to a whole range of other products and services, changed our culinary culture and had a lasting impact on our society. Thus, with the development of refrigerators, we did not merely experience the triumph of a technology in otherwise unchanged conditions, but profound socio-cultural change.

*“The theory of socio-cultural evolution seems to be a useful framework to denote the unpredictability of project outcomes, and thus the limits of causal explanations, in a scientific manner. This is not to deny that designers are able intentionally to design and manufacture a new teapot, a new aircraft, or a new constitution. But these designs are temporal interventions into evolutionary processes. Most results disappear, a few are integrated into the further process. Failures as well as successes become part of the socio-cultural archive of humankind.” (Jonas 2007, 195)*

Humans have always changed so much more than they sought to change with their inventions, and the history of food preservation shows the deep interconnections between the social and the technical spheres (cf. Latour and Roßler 2016, 7), or as Marshall McLuhan once put it: “For the ‘message’ of any medium or technology is the change of scale or pace or pattern that it introduces into human affairs” (McLuhan 2001, 8).

When we try to initiate sustainable developments through design today, we should be aware that we are always operating in complex socio-technical networks into which we have to weave our concepts with a great deal of care and modesty. From this point of view, engaging with the past becomes a downright duty for designers. Reflecting on the complex historical contexts in which products evolved is important not only for a historical understanding of these products, but also to realise their transformation and further development.

## **Conclusion**

We have shown that looking into the past brings useful insights that enrich the design for the future. From today's perspective, the past sometimes seems bizarre. For example, with today's access to food products from global cold chains, it seems unbelievable that ships could have carried frozen water across the world's oceans. This way of looking at things can encourage us to take possible futures more seriously, even if they still seem improbable from our current point of view.

It was also shown that under today's paradigm of sustainability, the past preserves ideas that we can use again – such as the separate cooling unit of the “Monitor Top”. These ideas could also

be developed from scratch, but the knowledge and experience of the past provides too much to be ignored. The ‘brand new idea’ is rarely as new as it appears to be. Designers are sometimes negligent or unaware about their historical references. Therefore, we try to promote a design practice that deals openly with its inspirations and points out its references. In addition to the benefits for the creative process, this approach would bring design practice one step closer to the idea of openly accessible knowledge. Communicating design references is currently mainly in the hands of design historians. That designers cite the ‘sources’ that informed their design process is the exception. While it remains unresolved how products might be able to reference non-textual citations, it is certainly a path worth exploring. This thought could become another aspect in the discussions that unfold around the so-called “Product Pass” (Götz, Adisorn, and Tholen 2021) – a product description that contains important information about its material composition.

At the end of the day, design is always re-design (Michl 2002). Some design processes are preceded by historical research, often without mentioning it. Our framework invites designers to engage more with historical reflections and encourages them to use – or admit – history as a source of inspiration.

As a metaphor, the *recycling of ideas* is well suited to emphasise how the so-called ‘Circular Economy’ is about more than closing material loops. The metabolism of materials can only be altered if you also enable ideas to metabolise. In addition to well-known tactics like urban mining, history mining could make a further contribution to achieving more sustainable product-service systems by closing information loops of different time horizons. Looking at history becomes a way of “mental window shopping” (Simon 1985, 188) for approaches that are to be reactivated and transformed. Everything that already exists or ever existed becomes both a resistance to and a potential for transformation processes.

## R E F E R E N C E S

- Amara, Roy. 1974. “The Futures Field: Functions, Forms, and Critical Issues.” *Futures : The Journal of Policy, Planning and Futures Studies* 6(4): 289–301. [https://doi.org/10.1016/0016-3287\(74\)90072-X](https://doi.org/10.1016/0016-3287(74)90072-X).
- Bakker, Conny, Marcel den Hollander, Ed van Hinte, and Yvo Zijlstra. 2020. *Products That Last 2.0: Product Design for Circular Business Models*. Amsterdam: BIS Publishers. <http://public.ebib.com/choice/PublicFullRecord.aspx?p=6350156>.
- Bickel, Manuel W. 2021. “Viable Communication Systems.” <http://pub-data.leuphana.de/frontdoor/index/index/docId/1107>.
- Blühdorn, I. 2017. “Post-Capitalism, Post-Growth, Post-Consumerism? Eco-Political Hopes beyond Sustainability.” *Global Discourse* 7(1): 42–61. <https://doi.org/10.1080/23269995.2017.1300415>.

- BMUB and UBA. 2015. "Ecodesign KIT." <https://www.ecodesignkit.de/home-willkommen/>.
- van Boeijen, Annemiek, Jaap Daalhuizen, Jelle Zijlstra, Roo van der Schoor, and Technische Universiteit Delft, eds. 2014. *Delft Design Guide: Design Methods*. 2nd ed. Amsterdam: BIS Publishers.
- von Borries, Friedrich. 2020. *The World as Project: A Political Theory of Design*. Prinseneek: Jap Sam Books.
- Brand, Stewart. 1995. *How Buildings Learn: What Happens after They're Built*. London: Penguin Books.
- Candy, Stuart. 2010. "The Futures of Everyday Life: Politics and the Design of Experiential Scenarios." Honolulu: University of Hawai'i at Manoa. <http://rgdoi.net/10.13140/RG.2.1.1840.0248>.
- Circular Economy Initiative Deutschland, ed. 2021. *Circular Economy Roadmap für Deutschland*. Munich: acatech/SYSTEMIQ. <https://www.acatech.de/publikation/circular-economy-roadmap-fuer-deutschland/>.
- Colomina, Beatriz, and Mark Wigley. 2016. *Are We Human? Notes on an Archaeology of Design*. Zürich: Lars Müller Publishers.
- Cui, Mengmeng. 2021. "Key Concepts and Terminology." In *An Introduction to Circular Economy*, edited by Lerwen Liu, and Seeram Ramakrishna, 17–34. Singapore: Springer Singapore. [https://doi.org/10.1007/978-981-15-8510-4\\_2](https://doi.org/10.1007/978-981-15-8510-4_2).
- David, Paul A. 1985. "Clio and the Economics of QWERTY." *The American Economic Review* 75 (2): 332–37.
- Dunne, Anthony. 2008. *Hertzian Tales: Electronic Products, Aesthetic Experience, and Critical Design*. MIT Press paperback ed. Cambridge, MA: MIT Press.
- Dunne, Anthony, and Fiona Raby. 2013. *Speculative Everything: Design, Fiction, and Social Dreaming*. Cambridge, MA: MIT Press.
- Ellen MacArthur Foundation and IDEO. 2018. "The Circular Design Guide." <https://www.circulardesignguide.com/>.
- Eno, Brian. 1995. "The Big Here and Long Now." *The Long Now Foundation* (blog). January 15, 1995. <https://longnow.org/essays/big-here-and-long-now/>.
- European Commission. 2016. "Ecodesign Working Plan 2016-2019." November 30, 2016. <https://eur-lex.europa.eu/legal-content/EN/TXT/?qid=1483960559694&uri=CELEX%3A52016DC0773>.
- European Environment Agency. 2017. "Circular by Design - Products in the Circular Economy." Publication No 6/2017. EEA Report. <https://www.eea.europa.eu/publications/circular-by-design>.
- European Union. 2008. "DIRECTIVE 2008/98/EC OF THE EUROPEAN PARLIAMENT AND OF THE COUNCIL of 19 November 2008 on Waste and Repealing Certain

- Directives.” <https://eur-lex.europa.eu/legal-content/EN/TXT/?uri=CELEX%3A02008L0098-20180705>.
- Frayling, Christopher. 1993. “Research in Art and Design.” *Royal College of Art Research Papers* 1(1): 5.
- Fry, Tony. 2011. *Design as Politics*. New York: Berg Publishers.
- Giedion, Siegfried. 1970. *Mechanization Takes Command: A Contribution to Anonymous History*. 3rd printing. New York: Oxford University Press.
- Götz, Thomas, Thomas Adisorn, and Lena Tholen. 2021. “Der digitale Produktpass als Politik-Konzept : Kurzstudie im Rahmen der umweltpolitischen Digitalagenda des Bundesministeriums für Umwelt, Naturschutz und nukleare Sicherheit (BMU).” Vol. 20. Wuppertal Report. Wuppertal: Wuppertal Institut für Klima, Umwelt, Energie. <https://doi.org/10.48506/opus-7694>.
- Greiff, Kathrin, Florian Fiesinger, Christa Liedtke, and Martin Faulstich. 2021. “C like Clever and Cycle : Without a Smart and Systematic Conception of the Metal Industry, Product Labelling and an Indicator System, Nothing Will Happen.” In *Sustainable Development and Resource Productivity: The Nexus Approaches*, edited by Harry Lehmann, 262–74. Abingdon: Routledge. <http://nbn-resolving.de/urn:nbn:de:bsz:wup4-opus-76243>.
- Gründl, Harald, and Institute of Design Research Vienna, eds. 2014. *Werkzeuge für die Design-Revolution: Designwissen für die Zukunft*. Sulgen: Niggli.
- Habs, Robert, ed. 1894. *Appetit-Lexikon*. Wien. <http://www.digital.wienbibliothek.at/wbrobv/2742994>.
- Hancock, Trevor, and Clement Bezold. 1994. “Possible Futures, Preferable Futures.” *The Healthcare Forum Journal* 37(2): 23–29.
- Hellmann, Ullrich. 1990. *Künstliche Kälte: die Geschichte der Kühlung im Haushalt*. 1. Auflage. Giessen: Anabas Verlag.
- Irwin, Terry. 2015. “Transition Design: A Proposal for a New Area of Design Practice, Study, and Research.” *Design and Culture* 7(2): 229–46. <https://doi.org/10.1080/17547075.2015.1051829>.
- Jonas, Wolfgang. 2007. “Design Research and Its Meaning to the Methodological Development of a Discipline.” In *Design Research Now: Essays and Selected Projects*, 254. Basel [u.a.]: Birkhäuser.
- Katz, Sandor Ellix. 2012. *The Art of Fermentation: An in-Depth Exploration of Essential Concepts and Processes from around the World*. White River Junction, Vt: Chelsea Green Pub.
- Latour, Bruno. 1999. *Pandora’s Hope: Essays on the Reality of Science Studies*. Cambridge, MA: Harvard University Press.
- . 2010. *Eine neue Soziologie für eine neue Gesellschaft*. Erste Auflage. Frankfurt am Main: Suhrkamp Verlag.



- Latour, Bruno, and Gustav Roßler. 2016. *Der Berliner Schlüssel*. Dritte Auflage. locked, No. 1. Berlin: Botopress.
- Liedtke, Christa, Köhlert Markus, Huber Kim, and Baedeker Carolin. 2019. "Transition Design Guide : Gestalten für das Heute und Morgen ; ein Guide für Gestaltung und Entwicklung in Unternehmen, Städten und Quartieren, Forschung und Lehre." Vol. 55. Wuppertal Spezial. Wuppertal: Wuppertal Institut für Klima, Umwelt, Energie. <http://nbn-resolving.de/urn:nbn:de:bsz:wup4-opus-73358>.
- McLuhan, Marshall. 2001. *Understanding Media: The Extensions of Man*. Reprint. Routledge Classics. London: Routledge.
- Meinel, Christoph, and Larry J. Leifer. 2011. *Design Thinking: Understand - Improve - Apply*. Understanding Innovation. Berlin: Springer-Verlag.
- Michl, Jan. 2002. "On Seeing Design as Redesign. An Exploration of a Neglected Problem in Design Education." *Scandinavian Journal of Design History* 12: 7–23.
- Museum of Applied Arts & Sciences. 2020. "GE 'Monitor Top' Refrigerator." <https://collection.maas.museum/object/210813>.
- Park, Boyoung, Aesun Shin, Sue K. Park, Kwang-Pil Ko, Seung Hyun Ma, Eun-Ha Lee, Jin Gwack, et al. 2011. "Ecological Study for Refrigerator Use, Salt, Vegetable, and Fruit Intakes, and Gastric Cancer." *Cancer Causes & Control* 22(11): 1497–1502. <https://doi.org/10.1007/s10552-011-9823-7>.
- Potting, José, M.P. Hekkert, Ernst Worrell, and Aldert Hanemaaijer. 2017. *Circular Economy: Measuring Innovation in the Product Chain*. The Hague: PBL Netherlands Assessment Agency. <http://www.pbl.nl/sites/default/files/cms/publicaties/pbl-2016-circular-economy-measuring-innovation-in-product-chains-2544.pdf>.
- Rao, Narasimha D., and Kevin Ummel. 2017. "White Goods for White People? Drivers of Electric Appliance Growth in Emerging Economies." *Energy Research & Social Science* 27 (May): 106–16. <https://doi.org/10.1016/j.erss.2017.03.005>.
- Redzepi, René, and David Zilber. 2018. *The Noma Guide to Fermentation: Foundations of Flavor*. Foundations of Flavor. New York: Artisan.
- Rendall, Alan D. 2008. *Partial Differential Equations in General Relativity*. Oxford Graduate Texts in Mathematics 16. Oxford: Oxford University Press.
- Rockström, Johan, and Pavan Sukhdev. 2016. "How Food Connects All the SDGs." <https://www.stockholmresilience.org/research/research-news/2016-06-14-the-sdgs-wedding-cake.html>.
- Schmitt, Emilia, Francesca Galli, Davide Menozzi, Damian Maye, Jean-Marc Touzard, Andrea Marescotti, Johan Six, and Gianluca Brunori. 2017. "Comparing the Sustainability of Local and Global Food Products in Europe." *Journal of Cleaner Production* 165 (November): 346–59. <https://doi.org/10.1016/j.jclepro.2017.07.039>.



- Simon, Herbert A. 1985. *The Sciences of the Artificial*. 4th printing. Cambridge, MA: MIT Press.
- Simonse, Lianne Willemina Laurenta. 2017. *Design Roadmapping*. Edited by Jianne Whelton. Amsterdam: Bis Publishers.
- Stahel, Walter R. 2019. *The Circular Economy: A User's Guide*. Abingdon: Routledge.
- Steffen, Will, Katherine Richardson, Johan Rockström, Sarah E. Cornell, Ingo Fetzer, Elena M. Bennett, Reinette Biggs, et al. 2015. "Planetary Boundaries: Guiding Human Development on a Changing Planet." *Science* 347 (6223): 1259855. <https://doi.org/10.1126/science.1259855>.
- Stelwagen, Rianne Eleonore, Petronella Margaretha Slegers, Liesbeth de Schutter, and Eveline S. van Leeuwen. 2021. "A Bottom-up Approach to Model the Environmental Impact of the Last-Mile in an Urban Food-System." *Sustainable Production and Consumption* 26 (April): 958–70. <https://doi.org/10.1016/j.spc.2020.12.039>.
- Täubrich, Hans-Christian, and Jutta Tschöcke. 1991. *Unter Null – Kunststeis, Kälte und Kultur*. Munich: C.H. Beck Verlag.
- Taylor, Charles W. 1990. "Creating Strategic Visions." Carlisle Barracks, PA: Strategic Studies Institute, U.S. Army War College.
- Thévenot, Roger., and J. C. Fidler. 1979. *A History of Refrigeration throughout the World*. Paris: International Institute of Refrigeration.
- Tischner, Ursula, and Heidrun Moser. 2015. *How to Do Ecodesign*. Edited by Umweltbundesamt. <https://www.umweltbundesamt.de/en/publikationen/how-to-do-ecodesign>.
- Toffler, Alvin. 1971. *Future Shock*. New York: Bantam Books.
- Voros, Joseph. 2003. "A Generic Foresight Process Framework." *Foresight* 5(3): 10–21. <https://doi.org/10.1108/14636680310698379>.
- Wilson, Bee. 2012. *Consider the Fork: A History of How We Cook and Eat*. New York: Basic Books.
- Wölfel, Sylvia. 2016. *Weißer Ware zwischen Ökologie und Ökonomie: umweltfreundliche Produktentwicklung für den Haushalt in der Bundesrepublik Deutschland und der DDR*. Hochschulschriften zur Nachhaltigkeit 70. Muni